

More open than ever before.

SCHÜCO

**FOLDING
SLIDING SYSTEMS
SCHÜCO AS FD 75/90.HI**

More open than ever before.

SCHÜCO

**FOLDING
SLIDING SYSTEMS
SCHÜCO AS FD 75/90.HI**





Limitless freedom	10
Interview with Kate Fischer	13
AS FD 75/90.HI – A new benchmark	16
The systems at a glance	18
Attachments to building structure	20
Opening types	22
Technical details	26
Design	27
Planning freedom	28
Functionality	30
Security	31
Tested and certified	34
Schüco showrooms	36
Planning data for architects	38
Everything from a single source	40
Imprint	42

CONTENTS





Bring the outside in and expand the interior: set new standards with the AS FD 75/90.HI folding sliding platform.

10
11



**LIMITLESS
FREEDOM**



The desire for transparency is a thread that runs through architectural history. It's about views in and out, light, a flowing space and the fascination with transcending boundaries.

It was not walls with windows, but walls that were all window – that is how architecture and design critic Edwin Heathcote described the Crystal Palace, built in Hyde Park in 1850/51, in an article in the Financial Times. It is a building that is no doubt considered a landmark for transparency in architecture. The designer of this enormous exhibition hall, Joseph Paxton, used no masonry whatsoever. Instead he had a large quantity of iron parts cast, which were then screw-fixed on site to carry the glass panes. For the time, this was just as revolutionary as Paxton's idea to integrate a huge tree into the building, in order to position the giant 93,000 m² “greenhouse” with a 41 metre-high transept in the park. As a result, both nature and light penetrate the building, creating a completely new feeling of space. Using transparency to perfectly combine the interior and the exterior became a driving force in architecture over the decades which followed. Take the Bauhaus for example.

Glass façades – the new walls

When someone says “Bauhaus”, it automatically brings to mind iconic architecture like the Dessau building by Walter Gropius or the Barcelona Pavilion by Ludwig Mies van der Rohe – bulky structures that are transformed into floating frameworks thanks to large-scale glass units. The “flowing space” perfectly connects the inside and outside so that they become one. The architecture is reduced to the essentials. Façades are open, light comes in and you have a clear view out. This clear view becomes typical of the style. It was Gropius' vision that this openness and lightness would free society of its historical shackles.

The aim was for maximum freedom to be created to support the residents to live in a more conscious way that is closer to nature. This would in turn make them happier. However, artistic exterior design was not included in the Bauhaus curriculum. Mies van der Rohe is one of the few Bauhaus architects to also consider the gardens, terraces, courtyards and squares around his buildings and design them with the help of gardeners. Later on, Richard Neutra came along with a new take on it: with his guiding principle, which he called “biorealism”, he always tried to bring people in contact with nature



Image, left:

The Crystal Palace (constructed from 1850 to 1851) is made of just glass and iron. A prime example of architecture that is flooded with light..

Image, below:

Spatial zones that flow into one another and large glass fronts lend transparency and spaciousness to the Barcelona Pavilion by Mies van der Rohe.



through architecture. As a result, his constructions were bright and permeable, embedded in carefully arranged gardens and landscapes which became part of the living experience.

Extremely light, incredibly transparent

The call for transparency in architecture still echoes unmistakably today. The demand for large windows and sliding systems is rising steadily. This is not surprising as human beings were fundamentally born to live outside. However, the average European spends around 90% of their time in enclosed spaces. This is a challenge for architects, as how warm, bright or green our environment is has a direct impact on our spiritual and physical wellbeing – particularly for a population that increasingly occupies urban spaces in a highly mechanised, internet-driven world.

Glass sliding door systems used as part of the design of light and airy rooms are a key trend in residential and commercial building. Whilst they are constantly being further developed in terms of technology and aesthetics, they also permit ever-greater design freedom.

The new folding sliding generation

Optimum daylight through the targeted connection of inside and outside thanks to maximum transparency – this is what the new generation of Schüco folding sliding systems is designed for. With extremely narrow face widths of 90 mm and vent widths up to 1500 mm, the new Schüco AS FD 75/90.HI platform enables a highly transparent building envelope to be created even when closed. Depending on the type of folding sliding system, the vents can also be folded into very slimline stacks and moved to the side almost silently. Maximum opening widths without fixed vents or fixed lights can therefore be created with Schüco AS FD 75/90.HI.

This promises not only unrestricted views but also an incredible feeling of open space. Boundaries disappear – not least thanks to the flat threshold – making the new Schüco AS FD 75/90.HI a versatile sliding system for both residential and commercial projects.

Image below:

What follows transparency? Openness! The new Schüco AS FD 75/90.HI platform removes the boundary between inside and outside, providing a maximum opening area – just like in the home of British architect Kate Fischer.

12
13



Interview with architect Kate Fischer



Schüco: How important is “transparency” in your architecture?

KF: A connection with nature is of fundamental importance to our physical well-being. That’s why I try to make natural light, the changing seasons and the surrounding flora and fauna something you can experience in all of my projects. To do this, the key lines of sight, the direction of the sun and the movement patterns of the residents are all carefully checked in advance. The design strategies incorporate high thermal insulation values, minimal thermal bridging, appropriate shading and natural ventilation.

Schüco: Why are folding sliding systems on trend right now?

KF: As people are working from home more and more, they are becoming increasingly aware of their home environment and see the benefit of a link to the outside world. Daylight improves your mood and reduces the need for artificial lighting; natural ventilation is healthier than air conditioning. When combined with high-quality interior design elements, the interior space can be extended to the outside via the folding sliding system, blurring the boundaries.

Schüco: In your opinion, which criteria should folding sliding systems fulfil?

KF: First and foremost, a system like this has to be durable and easy to use. Ideally, the design is closely coordinated with the manufacturer in order to ensure that sufficient tolerance is taken into account for the vent dimensions. The profile widths should be as narrow as possible to retain transparency when closed. To prevent this area becoming a weak point in the building envelope when it is cold, the

glazing should have low U values and the frame should be free from thermal bridging.

Schüco: To what extent do the Folding Design sliding doors contribute to the overall concept of your projects?

KF: Our concepts are all about restoring and upgrading traditional architecture made from brick and flint by adding on extensions with contemporary, contrasting designs. The transparent units show off the traditional features to their best advantage. Old buildings had small window openings which protected against the wind and rain but did nothing for the view. Premium folding door systems allow us to combine historic homes with breathtaking scenery, without compromising on energy efficiency. The highly transparent, glazed structure uses the thermal mass as a heat reservoir and regulates the temperature fluctuations.

Schüco: Thank you for talking to us.

Kate Fischer:

Founder of the Chiltern Architecture Studio, which specialises in the combination of traditional buildings that are typical of the area and contemporary, energy-efficient design concepts.







Schüco folding sliding systems are flexible space-savers. With maximum opening widths and transparency, they open up new dimensions of space.

16
17

**AS FD 75/90.HI –
A NEW
BENCHMARK**

Folding Design sliding doors

Flexible and space-saving: Folding Design sliding doors allow indoor spaces to blend perfectly with outdoor areas. Maximum opening widths ensure spacious doorways without fixed vents or fixed lights. Even when closed, the large, foldable glass units and narrow profiles create a transparent connection between the inside and the outside.

Folding Design sliding doors can be perfectly tailored to the requirements and desires of different users and are ideal for a wide range of different installation scenarios in the residential and commercial sectors – for anyone who wants more space to flourish. While in the private sphere they allow living spaces and terraces or gardens to become one, they impress in shops, hotels and restaurants in particular with their flat thresholds for easy access.

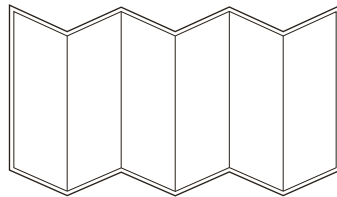

The platform in detail

With Schüco AS FD 75 (Aluminium Sliding Folding Door) and Schüco AS FD 90.HI (High Insulated), the new folding sliding system platform combines sliding functionality and glass façades for more transparency than ever before.

1 Clean design With its completely flush frame concept, limited visible joints and narrow face widths of just 90 mm, the AS FD 75/90.HI enables high-quality design solutions to be created which blend harmoniously into the building architecture.

2 Maximum planning freedom The folding sliding system offers new planning and design options for residential and commercial construction projects. Large vent dimensions and vent weights are possible as well as a wide range of opening types. Three different threshold types are also available.

3 Unrestricted functionality The large selection of opening and locking options enables many different requirements and demands to be met without restrictions. The integrated side-hung vent provides a quick-access doorway. A maximum opening width also brings the inside out.









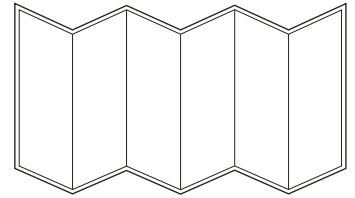







**Schüco AS FD 75/90.HI fulfils
the highest architectural demands
and impresses right down to the last detail.**

18
19



THE SYSTEMS AT A GLANCE



PROPERTIES	SCHÜCO AS FD 75	SCHÜCO AS FD 90.HI
 Vent basic depth	75 mm	90 mm
 Max. vent width	1500 mm	1500 mm
 Max. vent height	3000 mm	3500 mm
 Vent weight	150 kg	150 kg
 Face width at the vent joint	90/104 mm	90/104 mm
 Glass thickness	5–38 mm/5–50 mm	30–53 mm/20–65 mm
 Air permeability	Up to class 4	Up to class 4
 Wind load resistance	C3/B5	C3/B5
 Watertightness	E750	E750
 Thermal insulation*	From 1.1 W/(m ² K)	From 0.8 W/(m ² K)
 Sound reduction	Up to 47 dB	Up to 47 dB
 Burglar resistance	RC 2/PAS 24	RC 2/PAS 24
 Manual operation	Yes	Yes
FEATURES		
 Threshold height	4/15/71 mm	4/15/71 mm
 Monitoring of closing	Yes	Yes
 Side-hung vent	Yes, optional	Yes, optional
 Opening types	68	68

*Type 3 LH/3 RH, continuous outer frame, (W x H) 4000 mm x 2500 mm, Ug 0.5 W/m²K

The new folding sliding system platform combines sliding functionality and glass façades. The result is a highly transparent building envelope which can be almost completely opened.

20
21

**ATTACHMENTS TO
BUILDING STRUCTURE**

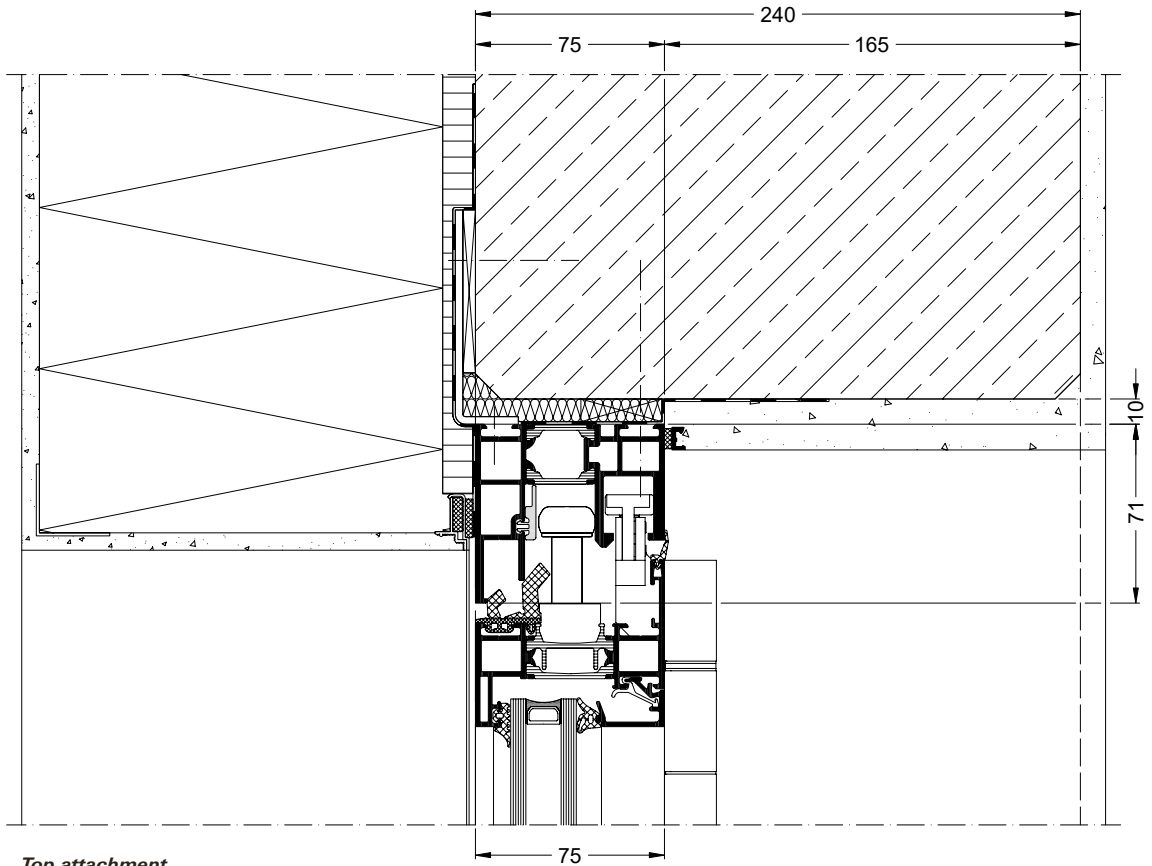

Top attachment
 The Schüco AS FD 75 with
 composite thermal insulation
 system

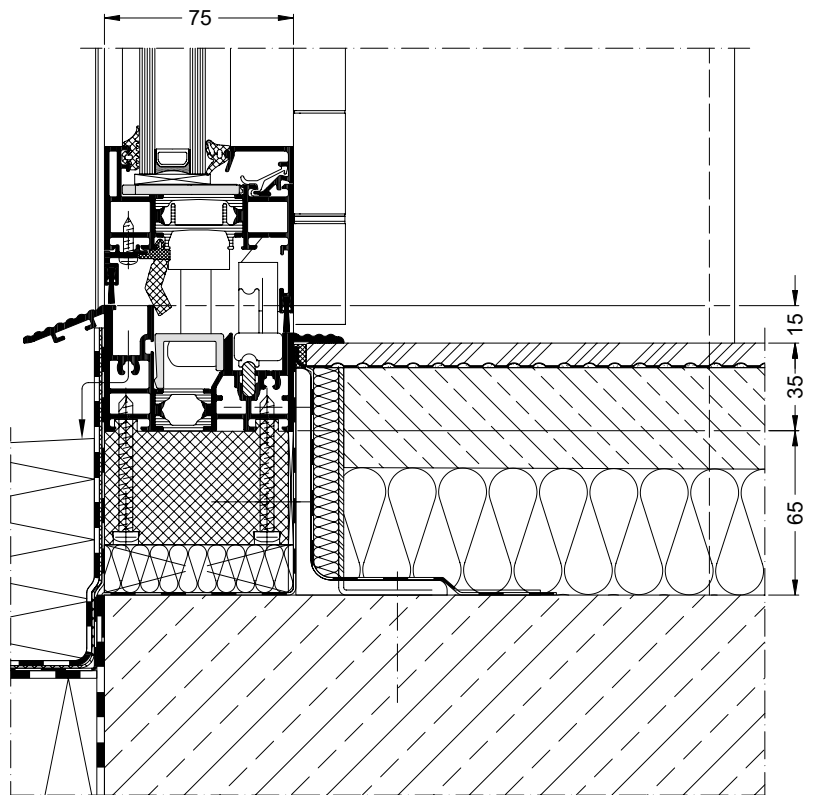

Bottom attachment
 The Schüco AS FD 75
 with 15 mm threshold

**Easy and almost silent opening:
the units can be folded inwards
or outwards, either in one
direction or to the left and
right like curtains.**

22
23

OPENING TYPES

Type 3L

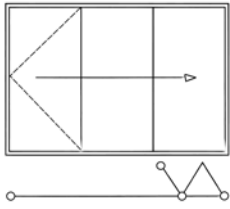

Type 5L

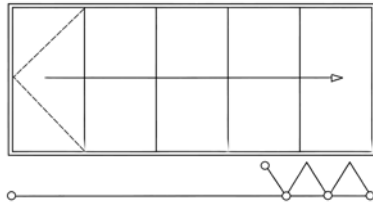

Type 7L

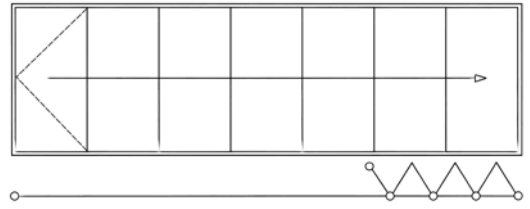

Type 2L

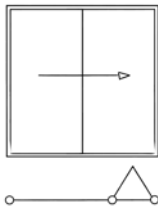

Type 4L

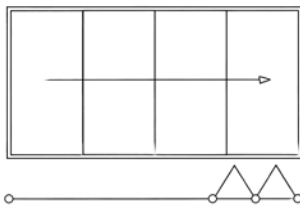

Type 6L

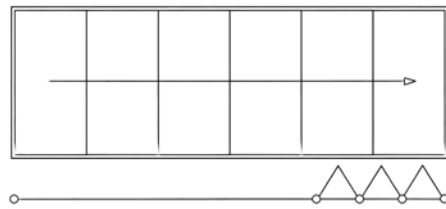

Type 3L/3R

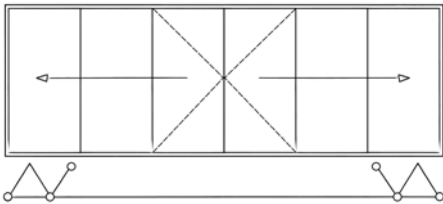

Type 3L/1R

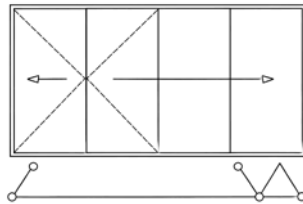

Type 5L/1R

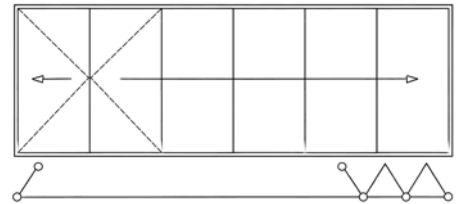

Type 2L/2R

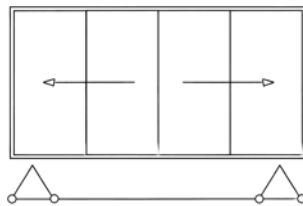

Type 4L/2R

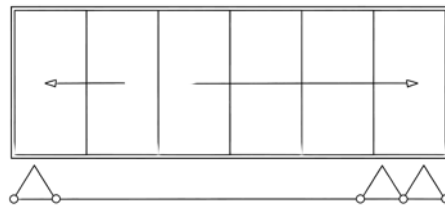

Type 2L/1R

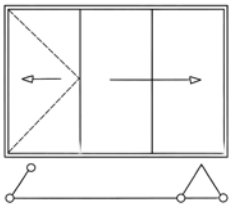

Type 3L/2R

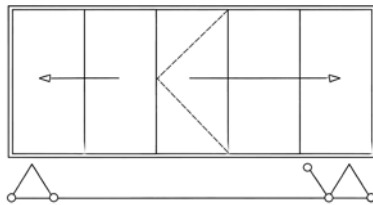

Type 4L/3R

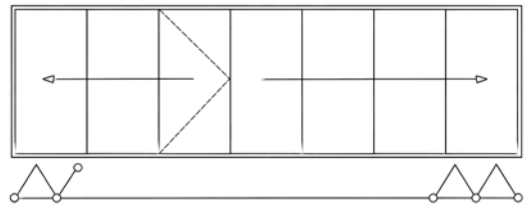

Extensive design freedom

When planning, there are 68 different opening options to choose from.

This means that almost any idea can be put into practice.





**All the details about design,
planning freedom and functionality.**

26
27

TECHNICAL DETAILS

Design

Narrow face widths

For a thermally broken folding sliding system, Schüco AS FD 75 / 90.HI offers extremely narrow face widths of 90 mm. The benefit of this is a higher proportion of glass to frame and therefore greater transparency when the vents are closed, which is further enhanced by vent widths of up to 1500 mm. The 90 mm narrow face widths are made possible by the innovative, space-saving vent frame concept, which involves the positioning of the shoot bolt and gearbox in the centre of the vent joint. When closed, the fittings components are concealed by a U-shaped PVC-U profile. This ensures both generous views and indoor spaces flooded with light.

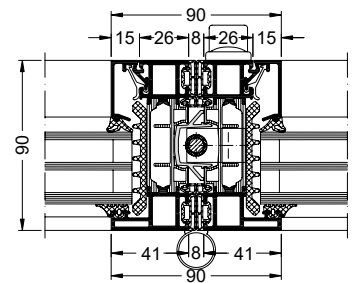
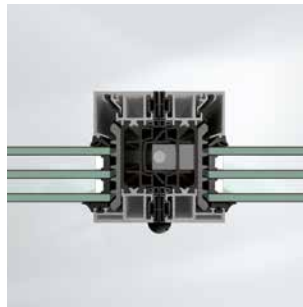
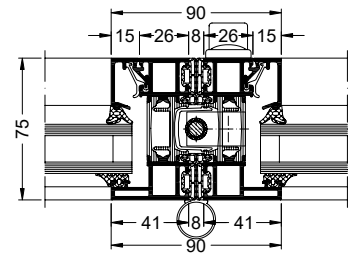
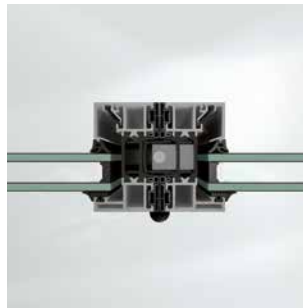

Minimalist look

Thanks to the completely new profile concept with flush transitions and largely concealed joints and fittings, the system solutions are very attractive when closed. The numerous standard supplementary profiles are integrated in the main profiles and are not visible. The result is a minimalist, two-dimensional overall look of the folding sliding unit, without any obtrusive steps, offsets or protruding frames.

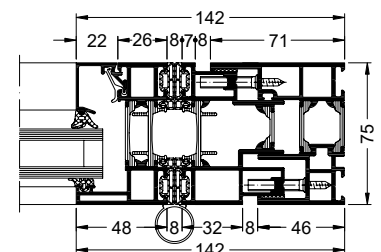
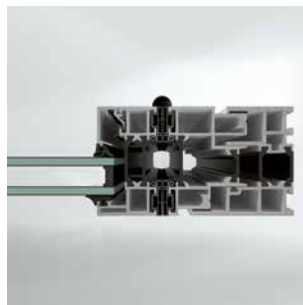
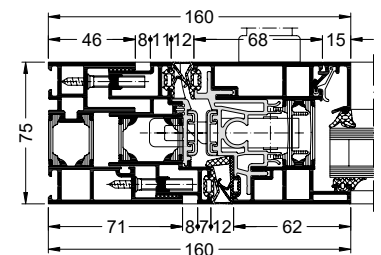
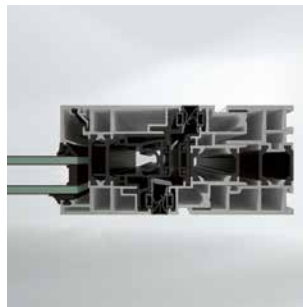

Planning freedom

Vent width, height and weight

Schüco AS FD 75/90.HI is a highly flexible system platform which guarantees maximum planning freedom, even where very large folding sliding units are concerned. Vent heights of up to 3000 mm are possible for Schüco AS FD 75, and up to 3500 mm for AS FD 90.HI which has a larger basic depth. Even in the standard design, vent weights of up to 150 kg are possible for both basic depths.

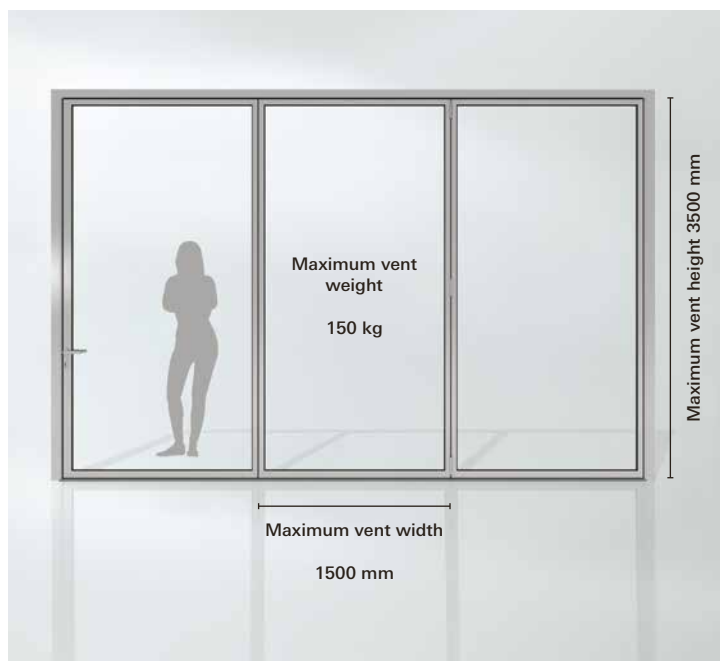

28
29

Schüco design line handles

Handles and pull grips that are specifically tailored to the requirements of Schüco folding sliding systems fulfil high demands in terms of functionality and design. With its consistent style, the Design line folding sliding range fits in seamlessly with the Schüco window and door Design lines. Door handles, flat handles and pull grips are easy to operate, technologically advanced and highly attractive, with clean lines which make an additional design statement.



Three threshold options

The **4 mm** threshold solution is particularly suitable for busy entrance areas, because trip hazards are avoided. The exclusive use of brush seals means that additional protection against driving rain is necessary, for example by means of a canopy.

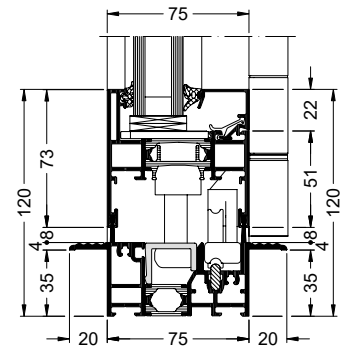

The **15 mm** flat threshold with a single gasket rebate is designed for easy access. The rebate gasket and high drainage channel depth in the threshold profile ensure excellent performance with regard to weathertightness and thermal insulation.

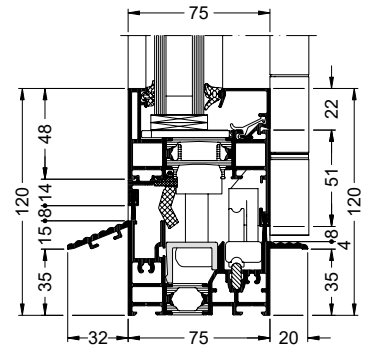

The **71 mm** high continuous outer frame offers maximum weathertightness and thermal insulation thanks to its double gasket rebate. In the outward-opening version, this threshold solution is particularly suitable for renovation projects as the outer frame profile can accommodate any height differences between the inside and outside areas.

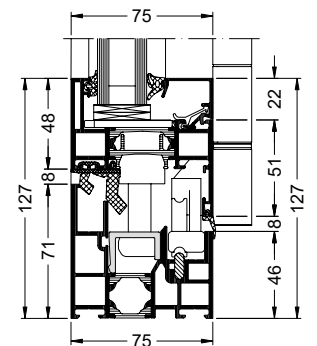

Functionality

Maximum opening width

The folding sliding function ensures maximum opening widths alongside high levels of transparency. The system offers generous views when closed and seamlessly extends the living space when open. Further benefits include no fixed lights and no fixed vents when open, for plenty of daylight and fresh air.



Side-hung vent

When the folding sliding system is closed, the optional side-hung vent acts like an entrance or room door for quick access. In this way, the sliding system also gains the functionality of a door system. The side-hung vent can be positioned anywhere in the unit. In addition, there is the option to integrate two side-hung vents with double-vent units.



Opening types and locking options

The large selection of opening types enables a wide range of different requirements and demands to be met without restrictions – for architects and planners as well as users. The extended range of locking options offered for Schüco AS FD 75/90.HI provides increased ease of use, as well as improved watertightness and air permeability. Handle-operated multi-point locking is available for the side-hung vent and can be fitted with an additional shoot bolt for vent heights over 2600 m.



Security

Burglar resistance without much additional effort

The issue of security is an important part of the new platform, with many opening types being able to be designed as burglar-resistant without much additional effort. Glass bonding is not necessary for this. Schüco AS FD 75/90.HI is tested and certified to resistance class RC 2 and PAS 24. Added security is achieved through the lockable gearbox and an additional locking point in the vent joint.

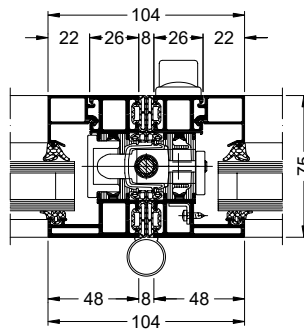

Monitoring of opening and closing

The folding sliding system can also be enhanced with monitoring of opening or combined monitoring of opening and closing. With the aid of the Schüco magnetic switch, you can monitor whether a moveable unit is open, closed, locked or unlocked. The magnetic switch is integrated in the profile and cannot be seen when opening units are closed. It also fulfils VdS classes B and C, which means it guarantees the highest level of protection against sabotage and can be used for special applications in burglar alarm technology.

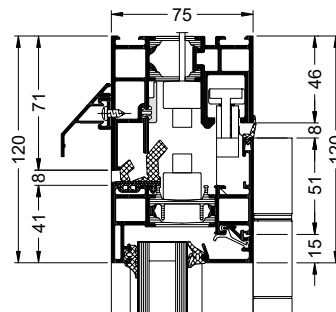





The Schüco Technology Center in Bielefeld is one of the world's leading test centres for windows, façades, doors and sliding doors.

34
35

**TESTED
AND CERTIFIED**



For almost half a century, we have been intensively studying the performance of materials and structures in relation to a range of different external factors and loads. We use this expertise to inform our own product development and, as a manufacturing laboratory, support our partners with project-specific testing services. The Schüco Technology Center is accredited as an independent (manufacturing) test laboratory by the national accreditation body for the Federal Republic of Germany (DAkkS). We offer reliable, independent results based on globally recognised standards of excellence in the fields of testing equipment, personnel and organisation.

Testing and optimisation

The core specialist areas of the Schüco Technology Center include component, material and environmental simulation tests. The Technology Center has been extended to include a large building acoustics hall, making space for new, highly flexible laboratory technology.

Research and development

Constantly optimising new systems and validating the results: Using our own test samples, we test the long-term serviceability and ageing behaviour of materials under the influence of heat, cold, moisture and UV light.

**Visit one of our showrooms in Germany
for information, inspiration and a special
experience.**

**36
37**

**SCHÜCO
SHOWROOMS**



One physical exhibit can tell you more than a thousand images. And a personal consultation from the experts is essential when it comes to the design of your building project. So go ahead and discover the Schüco range of products up close and in person at one of our showrooms or our partners' showrooms.

Berlin

Schlüterstraße 40
10707 Berlin, Germany

Bielefeld

Karolinenstraße 1 – 15
33609 Bielefeld, Germany

Düsseldorf

Franziusstraße 6
40219 Düsseldorf, Germany

Frankfurt am Main

Thurn-und-Taxis-Platz 6
60313 Frankfurt am Main, Germany

Hamburg

Watermark Tower HafenCity
Überseeallee 10
20457 Hamburg, Germany

Weißenfels

Selauer Straße 155
06667 Weißenfels, Germany

Wertingen

Industriestraße 12
86637 Wertingen, Germany



For the latest information about the locations, opening times and contact addresses, visit our website.

With consultancy, digital solutions and inspiration, Schüco supports you at every stage of your building project – from the initial idea and planning, right through to fabrication and installation.

38
39

**PLANNING DATA
FOR ARCHITECTS**

Specification texts

Our specification service for you

Regardless of the award procedure – public or not – our performance specifications provide you with a foundation for the reliable cost planning of construction work. Our free, product-specific specification items include sliding doors and sun shading, for example, as well as functions such as burglar resistance. You can find our specification texts on our website or in Docu Center.



PLAN.ONE

Independent comparison portal for building products

PLAN.ONE is a central database where you can carry out a manufacturer-independent search for building products in seconds and which you can use for your digital planning. Standardised product properties enable you to quickly compare all of the products. In the data archive, you can view relevant planning information (CAD data, specification texts and more) centrally and free of charge.



Architect website

Inspiration, information and new developments

Find out all about the other Panorama Design and lift-and-slide systems on our website. In addition to a wealth of inspiration, you will also find all of the products in detail. The practical product filter will help you to find the right solution for your building project.



Schüco Docu Center

Technical documentation and information

In Docu Center, you can find planning guidelines, system solutions, application options, attachments to building structure, section details and much more in addition to product data and certificates. Specifically developed for mobile use, the Schüco TecDoc app allows you to view all of the important documents on your smartphone too.



BIM objects

Planning data for BIM users

Building information modelling (BIM) is a new approach to the planning and realisation of construction projects as well as the operation of buildings. At its core is a digital data model that is used to create the planned construction project virtually before building work actually starts. Schüco supports users of the BIM method with planning modules and section details.



**Do you have any
questions?
service@schueco.com**

**You shape how we will live
and work in the future –
we develop the products.
Together, we create buildings
that broaden horizons –
in terms of architecture,
technology and people.**

40
41

**EVERYTHING FROM
A SINGLE SOURCE**

Schüco International KG offers high-quality systems for building envelopes made from aluminium such as windows, doors, façades and sun shading solutions, as well as consultancy services for architects, investors and clients. Our success is the result of innovation, partnerships, excellence and responsibility for people and the environment. After all, the buildings designed today determine how future generations will live and work. It is therefore our aim to be industry leaders in technology and service today and in future, so that we can help shape a good future together with you.

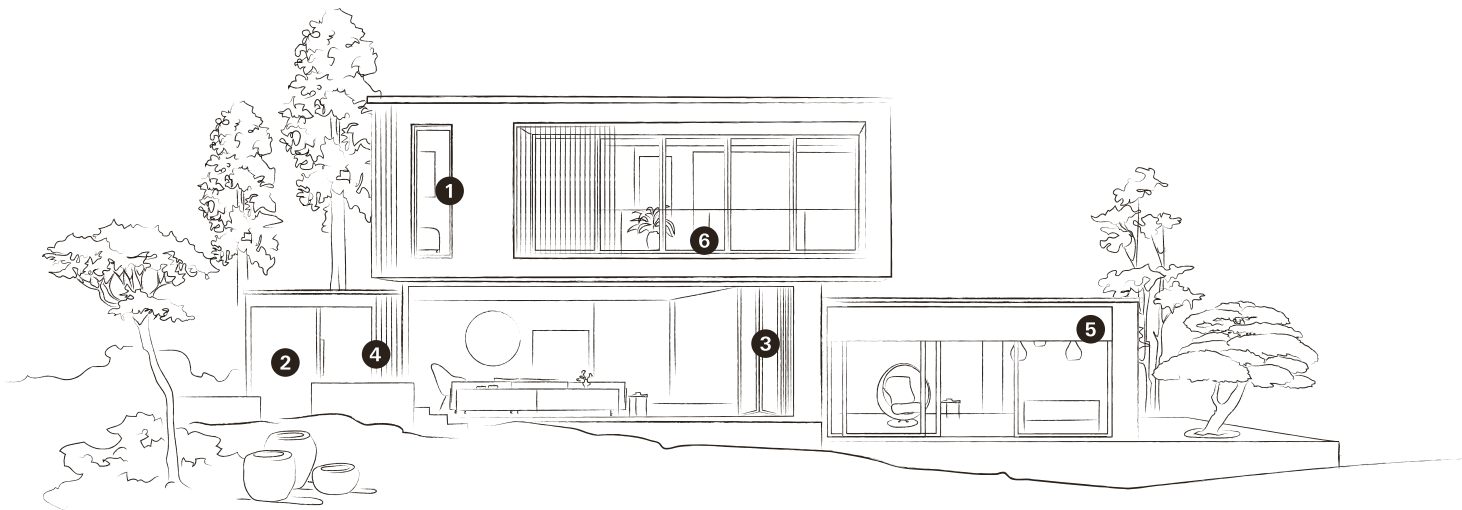

- ❶ **Schüco windows** Progressive functionality, year-round comfortable living and a purist aesthetic combined with an extensive range of fittings and handles, and a wide variety of colours.
- ❷ **Schüco doors** A range of sizes and contemporary designs allow for high levels of security, thermal insulation and functionality.
- ❸ **Schüco sliding doors** Versatile opening options and timeless design with maximum user comfort and transparency.
- ❹ **Schüco building automation** Clever automation solutions for individual windows, doors and sliding doors as well as fully networked systems for the entire building envelope.
- ❺ **Schüco sun shading** Attractive, varied sun shading and weather protection systems for a large-scale, individual façade design.
- ❻ **Schüco balconies** A wide variety of designs, optimum system compatibility, individual design options and a high level of weather resistance – suitable for newbuilds and existing properties.

Imprint

42
43

Publisher:

Schüco International KG
Karolinenstraße 1–15
33609 Bielefeld, Germany

Marketing and Editorial team:

Melanie Horsthemke
Lisa Landwehrjohann
Anna-Lena Schwarz

Concept and design:

entdecker*design

Illustration:

Ni" Jeanette Flick

Picture credits:

Shutterstock (p. 10/11)
John Selby (p. 12/13)
Lukas Palik (p. 37)

All other images:

Schüco International KG

Printing:

scanlitho.teams FullService GmbH

Production:

Druckerei Vogl GmbH & Co KG

P 4555/07.22

We reserve the right to make changes
and to correct errors.

Products may differ from illustrations.

Schüco International KG
Karolinenstraße 1–15
33609 Bielefeld

www.schueco.de

SCHÜCO